

Your Global Automation Partner

TURCK

excom I/O System for Ex and Non-Ex Areas





excom – I/O System for Ex and Non-Ex Areas

Compact, Easy to Integrate Remote I/O System

Turck's excom offers a universal Ethernet remote I/O system that can be installed in Zone 1/21, Zone 2/22 and C1D2 or in the non-Ex area. The field circuits are approved for Zone 0 and C1D1.

Whether via an Ethernet or fieldbus connection: The excom system integration to DCS/PLC like Rockwell, Emerson, Honeywell, Siemens, ABB, Yokogawa, Schneider is made easy and error-free thanks to detailed integration manuals and worldwide support.

The excom systems can be adapted to the number of signals to be connected and the space requirements on site thanks to module racks for 8, 16 and 24 I/O modules. The redundancy concept – each module rack can be run if needed with two power supply units and two communication gateways – gives you optimum availability.

The gateways act as masters to the internal data bus and as slaves to the higher-level fieldbuses PROFIBUS-DP as well as Profinet, EtherNet/IP and Modbus TCP.

The I/O density of up to 960 signals on five module racks in a standard control cabinet is the only one of its kind worldwide. The signal isolation from the Ex area is already integrated in the I/O system. This completely eliminates the need for control cabinets for safety barriers, as well as I/O cards in the control system.

This space benefit can be a critical factor, particularly in retrofit projects. Up to 192 digital or 96 analog signals can be connected via excom using a single IP address.



Rugged & Reliable: Approved for Ex & Non-Ex Areas

Modular System Design for Simple Customization

- A single system for all areas (non-Ex, Zone 1/21, Zone 2/22, C1D2)
- Application optimized system structure through modular concept
- High packing density through module racks for 8, 16 and 24 modules
- Up to 192 digital or 96 analog signals via one bus address
- Exchange and expansion of all components by inserting and removing all modules during operation (Hot Swap)

Maximum Uptime via Built-in Redundancy

- High availability through extensive redundancy concepts for PNO, line and system redundancy for all distributed control systems
- Full redundancy for power supplies and gateways
- Wide range of approvals for harsh environments

Engineered for Easy Use

- Standard and online configuration and setting of all parameters during operation (configuration in run)
- Webserver and DTM-based commissioning of the periphery and field instrumentation without control technology
- HART transparency from the process control system to the field device

Flexible Control System Integration

Simple connection to all standard process control systems of

- ABB
- Emerson
- Honeywell
- Siemens
- Yokogawa
- Schneider Electric
- Rockwell
- ...

Approvals



Installation Overview with Multiprotocol Ethernet

Cost-effective Networking Even in hazardous Areas

Now with Turck's excom system, users gain added flexibility with compatibility to multiple protocols and built-in redundancy, reducing costs vs other methods. Multiple topology configurations are possible with one system. Data can be sent either to the Cloud or to a traditional PLC via high-speed Ethernet. Configurations for hazardous and non-hazardous locations are shown below.

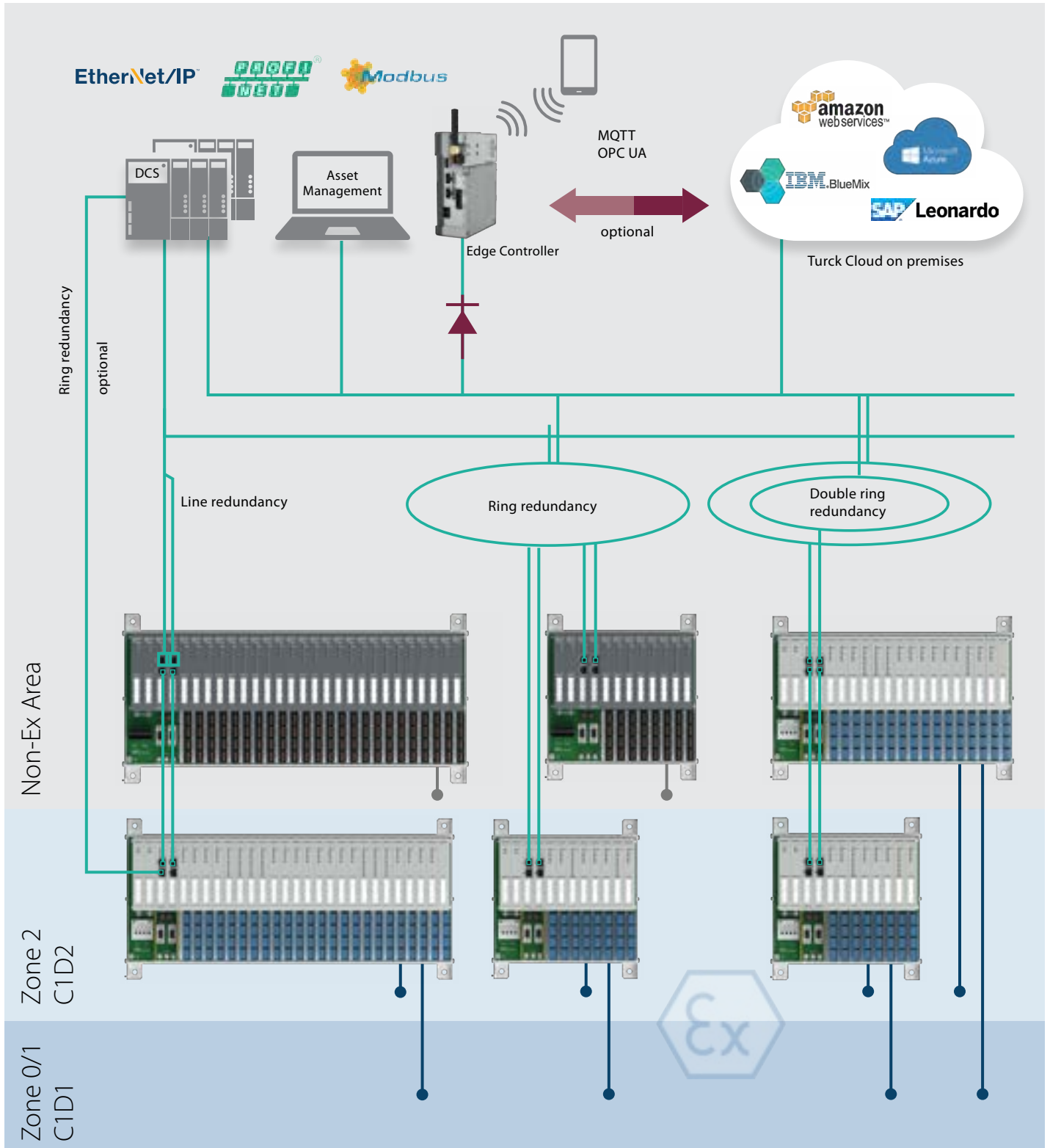

Installation Overview with Profibus-DP

Decentralized High-Speed Communication for Critical Data

Integrate excom into your PROFIBUS network for fast serial communication to a control system. Connections via fiber optic couplers or traditional RS-485 provides reliable communications in a range of industrial environments. Ex and non-Ex examples are shown below.

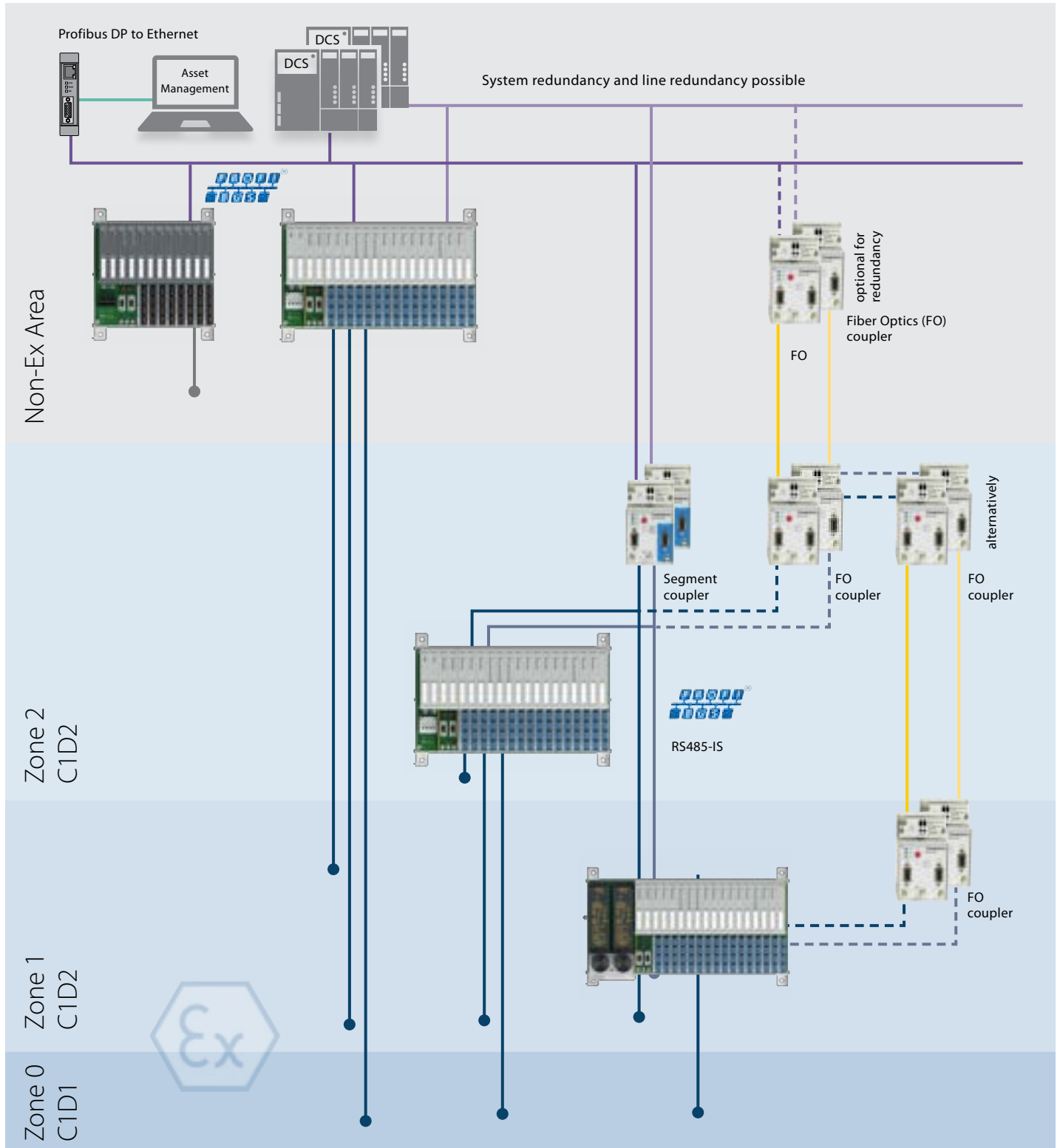



How to Choose a Remote I/O System

Hazardous & Non-Hazardous Locations

Safely transmit process data from sensors and actuators to controllers or the Cloud via Turck's remote I/O systems. These devices allow you to put I/O modules in the field – even in hazardous locations. You'll improve processes by managing the system near the point of use, reducing wiring and interruptions to the higher-level control system.

Consider the following key questions to simplify planning a decentralized system for Ex and non-Ex environments. Consult the experts at Turck to help you navigate the process. We can configure a system for you.

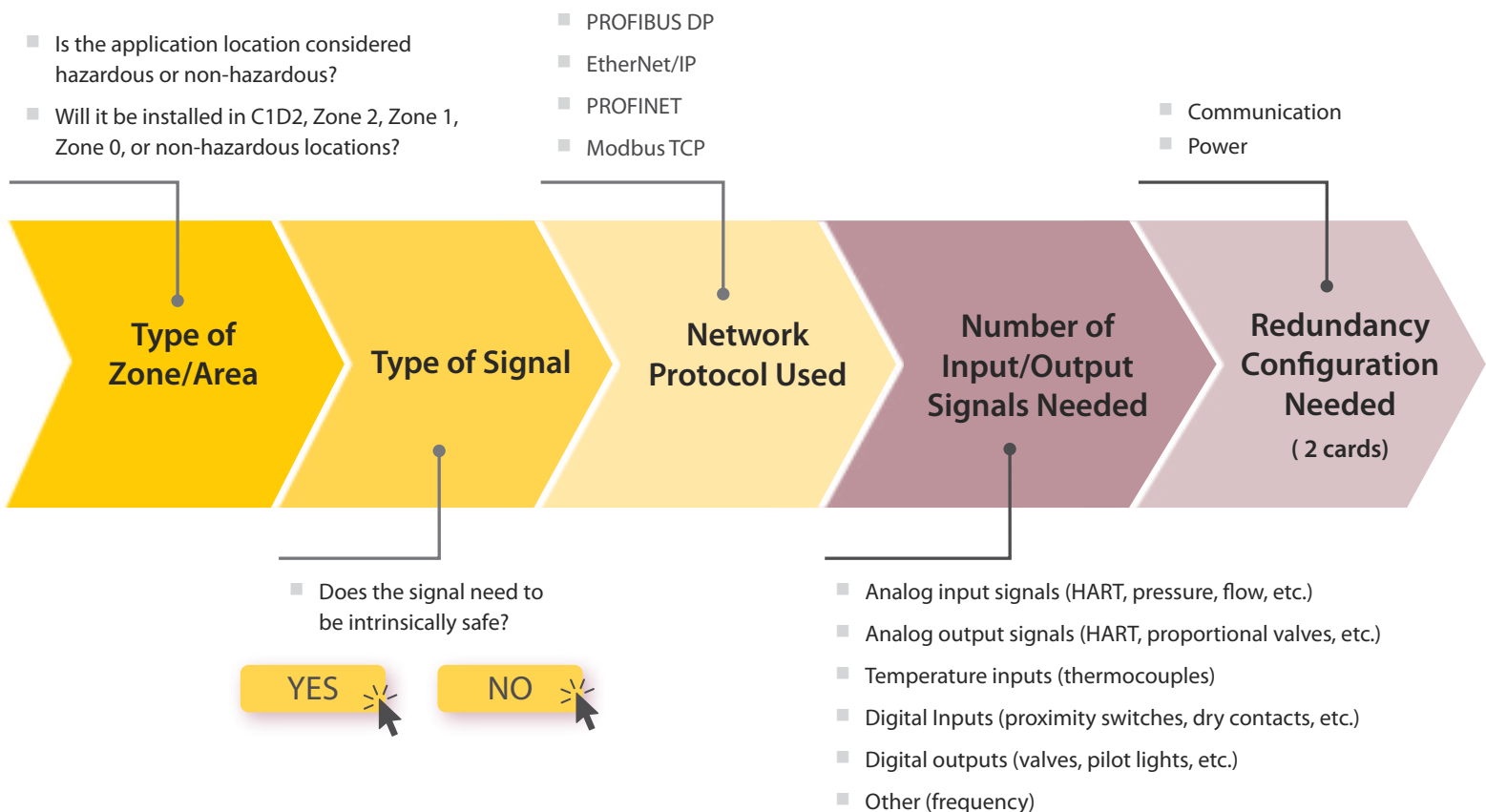

excom – System Configuration

Pre-Configured Systems Save Time & Costs

Using properly rated components and enclosures is the simplest method to maintain compliance in hazardous areas. Turck offers a wide range of devices rated for both hazardous and non-hazardous areas. They are available as pre-assembled systems to save on design costs. From I/O modules, to gateways, power supplies, terminals and more, devices are installed on a backplane per your application requirements. Integrators and end users save time and system design costs.

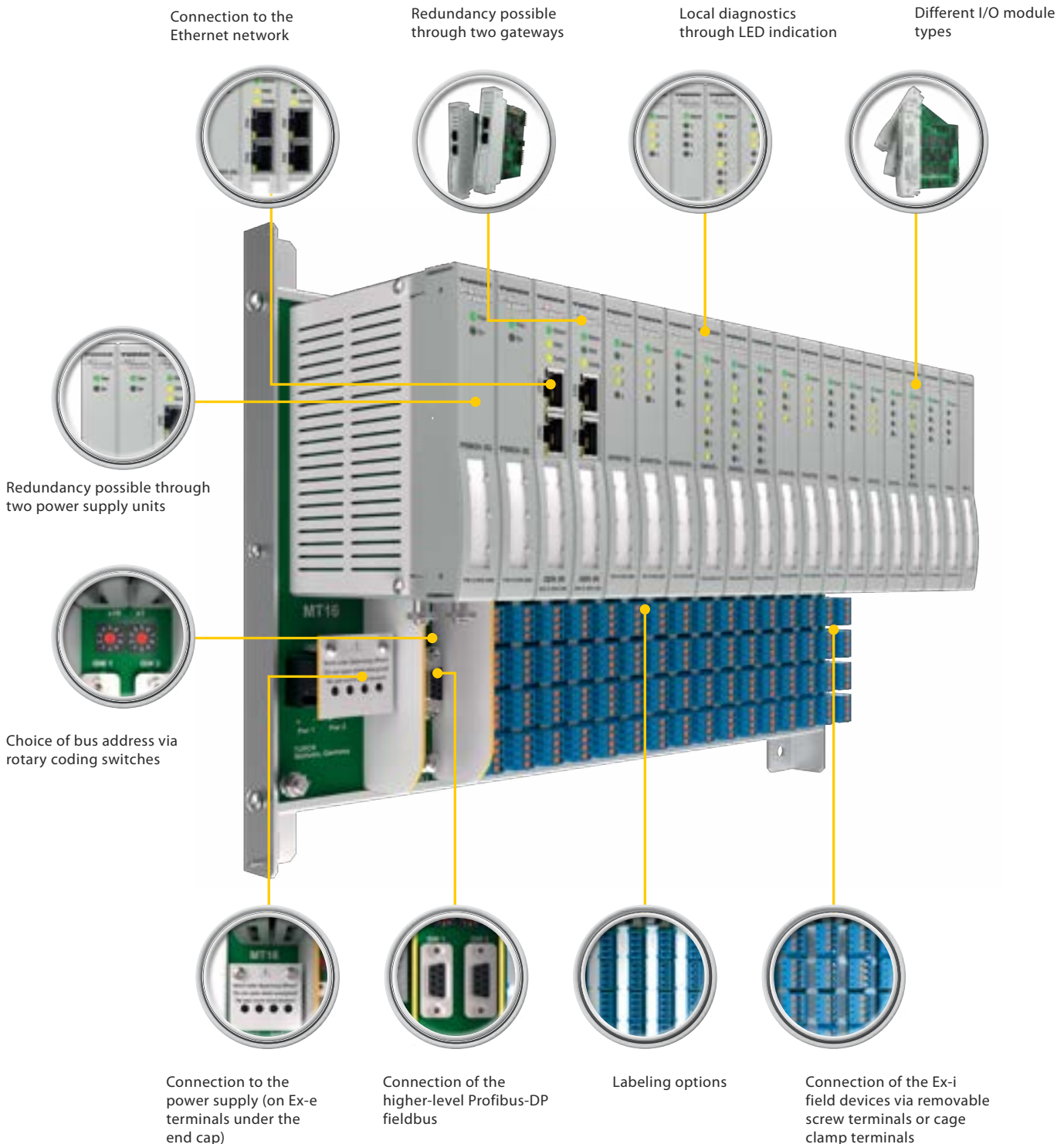

Excom - Types and Features

System for Ex 2G (Zone 1/C1D2) for Intrinsically Safe Circuits



Part Number	Module Rack			Gateway/Coupler				Power/Comm		I/O Modules								Terminals				
	I/O Modules			Protocol				24 VDC		Discrete In	Discrete Out	Discrete In/Out	Analog In-HART	Analog Out-HART	Temperature	Potentiometer	Frequency/Counter	Dummy	Dummy Power	Blue-16pcs/pack		
	8	16	24	Profibus DP	Multiprotocol Ethernet IP Profinet Modbus	RS485IS	IS Fiber Optic	Single	Dual	Ch	Ch	Ch	Ch	Ch	Ch	Ch	Ch	Ch	Ch	Screw	Spring	
										4	4	8	4	4	4	4	2	N/A	N/A			
MT08-2G	•							•														
MT16-2G		•						•	•													
GDP-IS/FW2.3				•																		
SC11EX-3G				•		•																
OC11EX/3G.2 PROFIBUS- KOPPLER				•			•															
OC11EX/2G.2						•	•															
PSD24Ex								•														
DI401Ex										•												
DO401Ex											•											
DM80Ex												•										
AIH401Ex													•									
AOH401Ex														•								
TI401Ex															•							
AI43Ex																•						
DF20Ex																	•					
BM1																			•			
BM-PS																				•		
STB16-4RS/1.5- BU																					•	
STB16-4RC/1.5- BU																						•

Quality Meets Flexibility

Turck's industry experience allows our team to provide customers with a complete packaged solution by integrating a combination of Turck or other manufacturer's products. We are fully certified, allowing the group to design and incorporate Turck interface modules, barriers, and hazardous area distributed I/O products into fully certified intrinsically safe control panels. Turck is also able to integrate our interface modules and excom products.

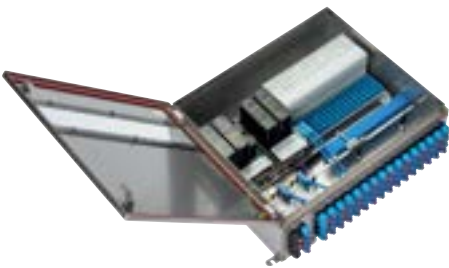

System solution benefit

Turck can also supply on request fully pre-assembled excom control cabinets, either as standard variants or with additional fitted components to your specifications. This has two clear advantages:

- You will receive system approval for the entire cabinet.
- You will receive proof of intrinsic safety for the complete system.



No new approval required even for expansions

The entire system is approved for the appropriate Ex areas. Thanks to the system approval, users can flexibly replace or even add gateways or I/O cards. Plant operators can carry out any necessary re-evaluation of temperature values themselves in the housing without the need for an external test body.

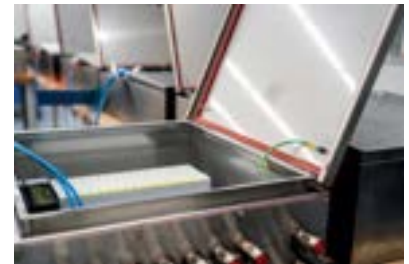

Turnkey Packaged Systems (TEPS)

Turnkey Packaged Systems (TEPS) offers complete electrical system solutions to customer specifications for all areas of industrial automation. Turck can also build excom control cabinets – either in a standard configuration or individually to customer specifications. The products and systems have been tried and tested in a several different projects and application conditions, including hazardous areas.



UL 508A
The standard for industrial control panels.



UL 698A
The standard for industrial control panels relating to hazardous (classified) locations.



UL 1203
The standard for explosion-proof and dust-ignition-proof electrical equipment for use in hazardous (classified) locations.



Ease of Use: Automated, Multiprotocol Communication



Connection to the Cloud

In addition to the exchange of process data with the control system, excom also features a second channel that provides the parallel data stream to any system. It is ideal for analyzing data first in an edge device and sending only these results to the cloud.

Turck also offers here alternative routes in addition to its proprietary cloud solution

with industry-specific data visualization and the encrypted Kolibri cloud protocol for the most demanding security requirements. The Turck cloud hardware also enables data to be transferred to one of the large cloud systems via MQTT or OPC UA.



Multiprotocol Ethernet

One gateway, three protocols:

- Turck's multiprotocol I/O devices detect the master after startup and adjust themselves automatically to the protocol
- PROFINET, Modbus TCP or EtherNet/IP
- Fully developed web server enables device configuration, I/O parameterization and diagnostics via a PC or mobile terminal devices
- Integrated Ethernet switch also enables line and ring topologies

Turck's multiprotocol Ethernet technology has become a proven solution in several products and market segments. The system can be used straightaway with all control systems supporting Profinet, EtherNet/IP or Modbus TCP, including:

- Siemens
- Honeywell
- Rockwell
- Yokogawa
- Emerson
- ABB
- ...

Maximum availability

excom supports Profinet S2 redundancy and ring topologies. Even for Ethernet protocols that do not have a native redundancy specification, excom establishes with its own specification either system redundancy, gateway redundancy or combinations of both options. This makes it possible to achieve maximum availability with all systems – irrespective of whether the control systems support the redundancy concept or not.

Besides network and protocol redundancy, excom also supports hot swapping, i.e. the ability to exchange all components during operation. This considerably simplifies maintenance work.

Future-proof thanks to parallel data access

Parallel data access technology brings IIoT to the process world. The data is routed beneath the control system level to a parallel IT structure. This ensures that control systems and process control are left untouched. Outside of these systems, the data can provide valuable information about efficiency and determine the prospective probability of failure of components. The increasing operating time of a valve closure may for example indicate corrosion or the formation of deposits. The findings from these analyses are routed on the operational control level in optimization cycles back into the processes – a fast and easy way to implement condition monitoring and predictive maintenance.

Network Topology

Line topology

I/O devices with an integrated switch enable networks to be created easily without any external switches. If a connection is broken, however, the downstream stations can no longer be reached.

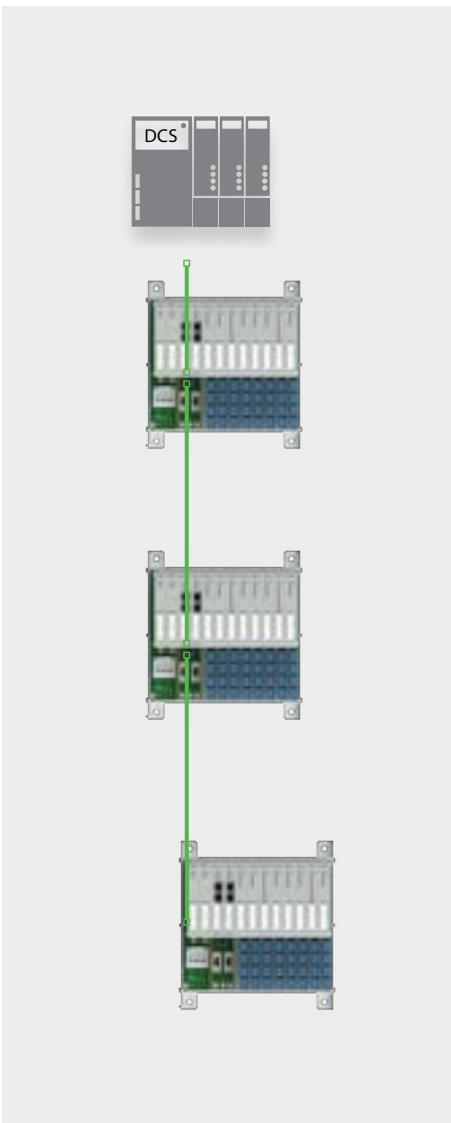

Star topology

All stations are connected via a switch. If one connection is broken, the remaining stations can still be reached.

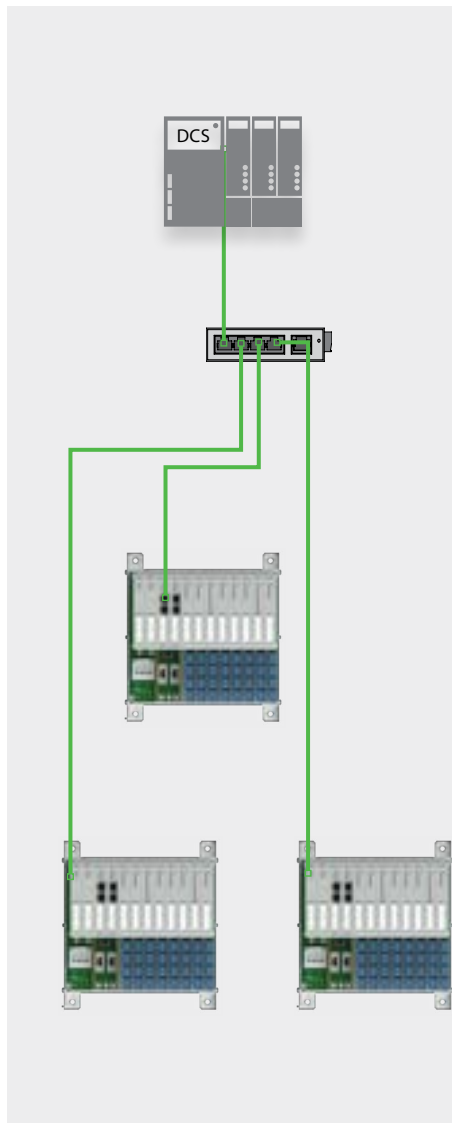

Ring topology

The line topology is extended into a ring topology by using a redundancy protocol. All stations must support the redundancy protocol (MRP or DLR).

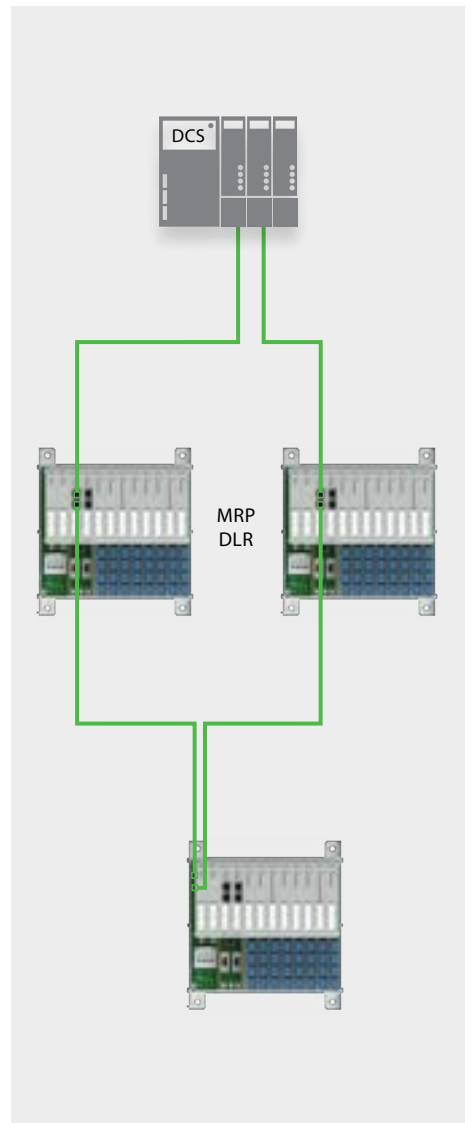

System Redundancy

2 masters and 1 gateway

- Profinet = S2

S2 describes physical redundancy at the control level and logical redundancy at the field device/gateway level through communication relationships to the primary control and backup control. If the primary control fails, the physical twin automatically takes over.

1 master and 2 gateways

- Turck's own solution for all systems possible

Simple and cost-effective redundancy concept for increasing availability at the connection level between the control level and gateways. Both gateways have a communication relationship with the control system and thus ensure that communication via the second gateway is maintained in the event of a gateway failure or line break.

2 masters and 2 gateways

Each gateway only communicates with one master

- Turck's own solution for all systems possible

The highest availability is ensured if both the master and the gateway are operated redundantly. In this case, the gateway communicates with only one master. The two masters negotiate internally who is the master and who is the backup master. With the intelligent excom solution, permanent system availability can be implemented.

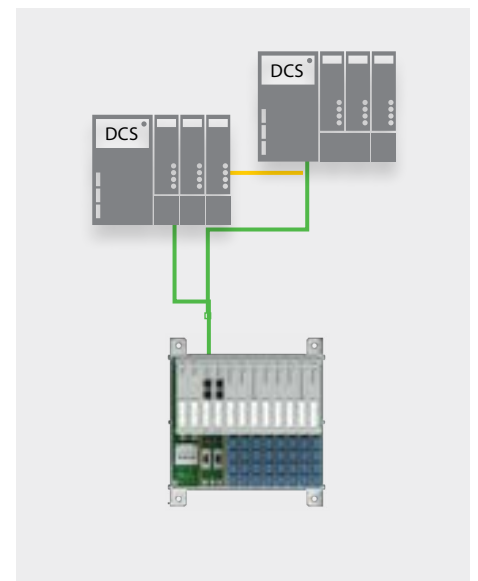
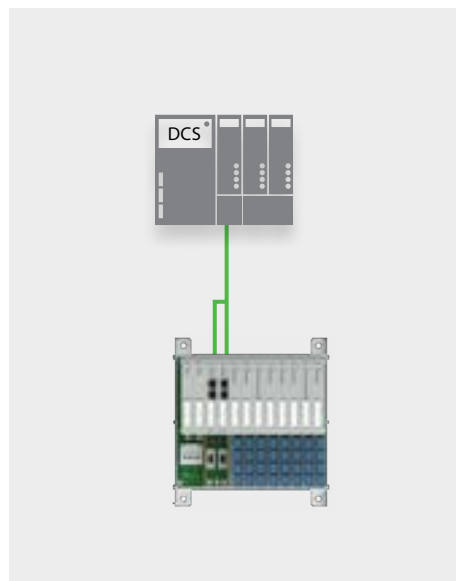
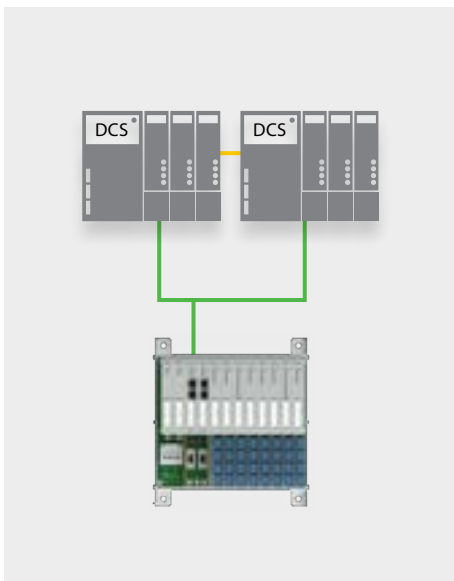

TURCK



30 subsidiaries and over
60 representations worldwide!

Printed in USA

©2024 by Turck Inc. All rights reserved. No part of the
publication may be reproduced without written permission.

B4105 B 02/24

www.turck.com